







<b>LED 2029 (3.5 A / 20 AWG)</b>	833.73.120	833.73.182	833.73.510	833.73.662
<b>LED 2045 (3.5 A / 20 AWG)</b>	833.73.121	833.73.183	833.73.511	833.73.680
<b>LED 2043 (3.5 A / 20 AWG)</b>	833.73.122	833.73.190	833.73.512	833.73.681
<b>LED 2037 (3.5 A / 20 AWG)</b>	833.73.123	833.73.191	833.73.513	833.73.682
	833.73.180	833.73.192	833.73.660	
	833.73.181	833.73.193	833.73.661	

732.28.253

HDE 11/2017

	<b>K</b>	<b>W</b>	<b>T<sub>A</sub></b>			
833.73.190	2700 K	9.6 W/m	-20 °C – +35 °C -4 °F – +95 °F	5000 x 10 x 1.3	≥ 20 x 11.3	
833.73.660						
833.73.191	3000 K					
833.73.661						
833.73.192	4000 K					
833.73.662						
833.73.193	5000 K					
833.73.180	2700 K	7.2 W/m				
833.73.181	3000 K					
833.73.182	4000 K					
833.73.183	5000 K					
833.73.120	2700 K	4.8 W/m				
833.73.121	3000 K					
833.73.122	4000 K					
833.73.123	5000 K					
833.73.513	2700 K	4.0 W/m				
833.73.680						
833.73.510	3000 K					
833.73.681						
833.73.511	4000 K					
833.73.682						
833.73.512	5000 K					

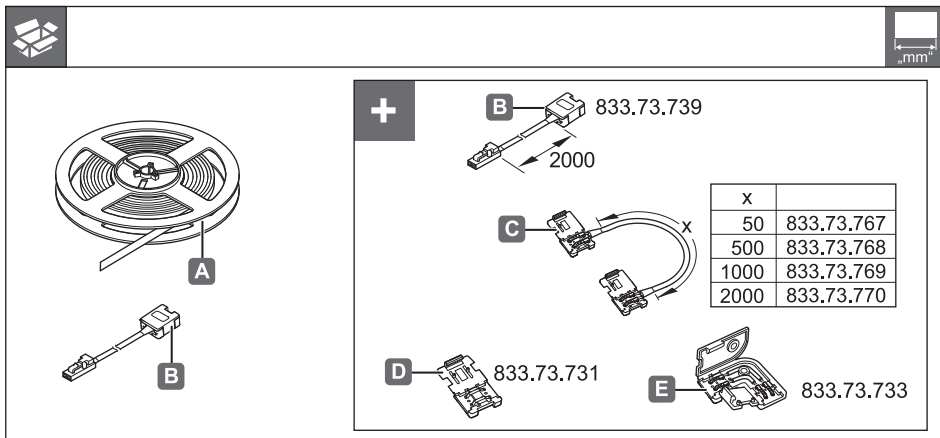

732.28.253

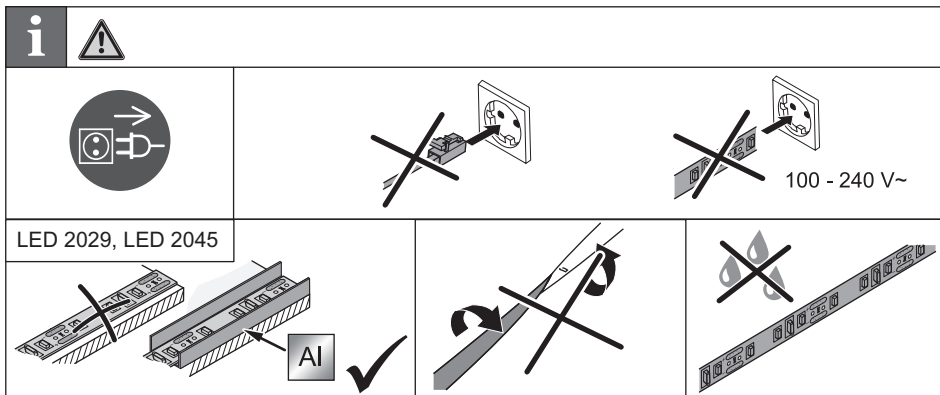

HDE 11/2017

1

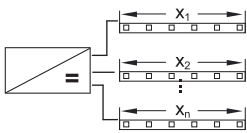
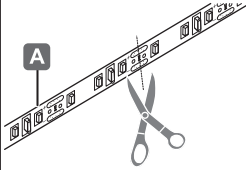

$$x_1 + x_2 + \dots + x_n = X$$

i

12 V / 6 W

	$x_n$ [m]	X [m]
LED 2029	0.450	0.450
LED 2045	0.600	0.600
LED 2043	0.900	0.900
LED 2037	1.100	1.100

12 V / 20 W (833.74.960, 833.74.961)

	$x_n$ [m]	X [m]
LED 2029	1.800	1.800
LED 2045	2.400	2.400
LED 2043	3.600	3.600
LED 2037	4.400	4.400

12 V / 40 W

	$x_n$ [m]	X [m]
LED 2029	3.600	3.600
LED 2045	4.800	4.800
LED 2043	5.000	<b>7.200</b>
LED 2037	5.000	<b>8.600</b>

12 V / 15 W

	$x_n$ [m]	X [m]
LED 2029	1.200	1.200
LED 2045	1.600	1.600
LED 2043	2.400	2.400
LED 2037	2.900	2.900

12 V / 27 W

	$x_n$ [m]	X [m]
LED 2029	2.150	2.150
LED 2045	2.900	2.900
LED 2043	4.300	4.300
LED 2037	5.000	5.000

12 V / 60 W (833.74.964, 833.74.965)

	$x_n$ [m]	X [m]
LED 2029	3.600	<b>5.500</b>
LED 2045	4.800	<b>7.400</b>
LED 2043	5.000	<b>11.000</b>
LED 2037	5.000	<b>13.300</b>

732.28.253

2

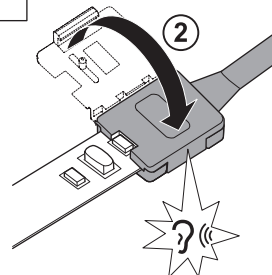
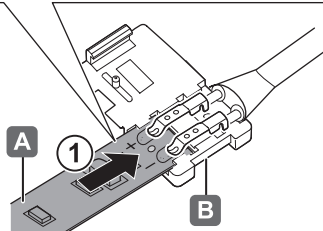
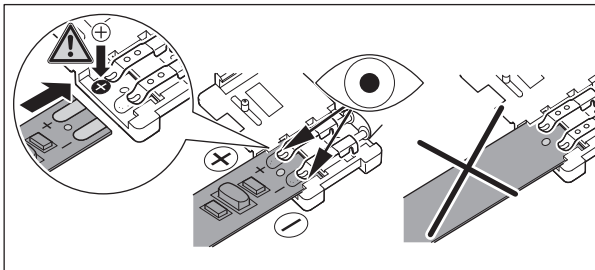

HDE 11/2017

3

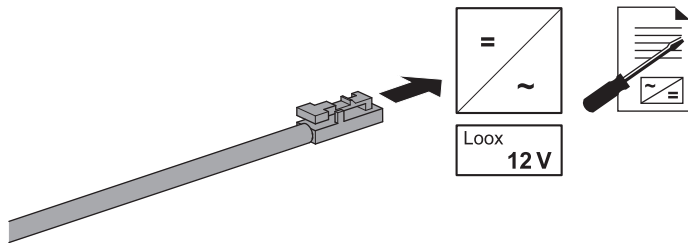

+

$r \geq 30 \text{ mm}$

$r < 30 \text{ mm}$

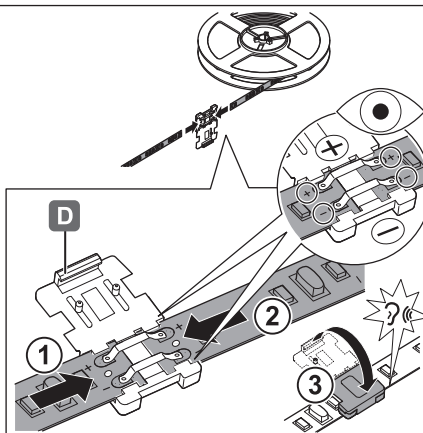
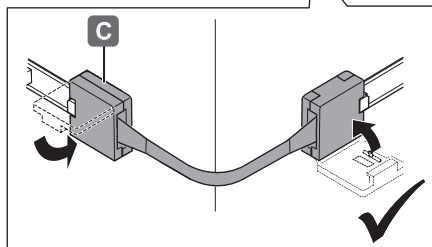
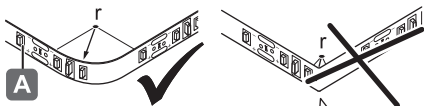

732.26.253

HDE 11/2017

