

## LOOX Mounting / Programming Instructions: Item no. 833.89.121

- The following are programming instructions for the Premium 6-Channel Remote for the Multi-Zone White Light Dimming Control System.

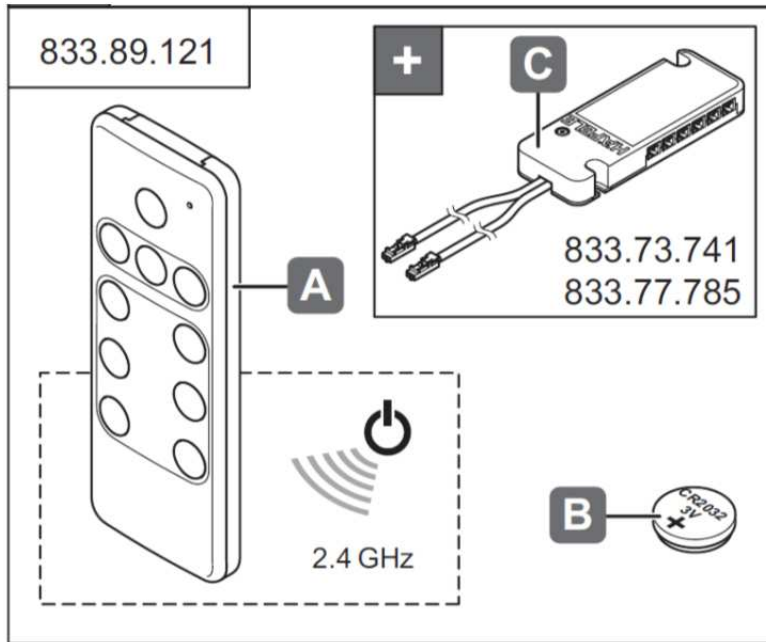

- The Wireless Remote, item 833.89.121, works with both 12v (833.73.741) and 24v (833.77.785) Receiver Modules.
- Up to 10 Receivers can be paired to a single Wireless Remote.

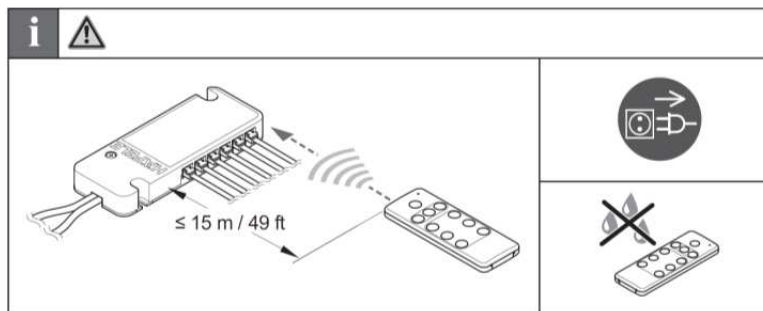

- Multiple Wireless Remotes (hand held remotes [833.89.121] and remote switches [833.89.122]) can be paired to each Receiver Module.

## LOOX Mounting / Programming Instructions: Item no. 833.89.121

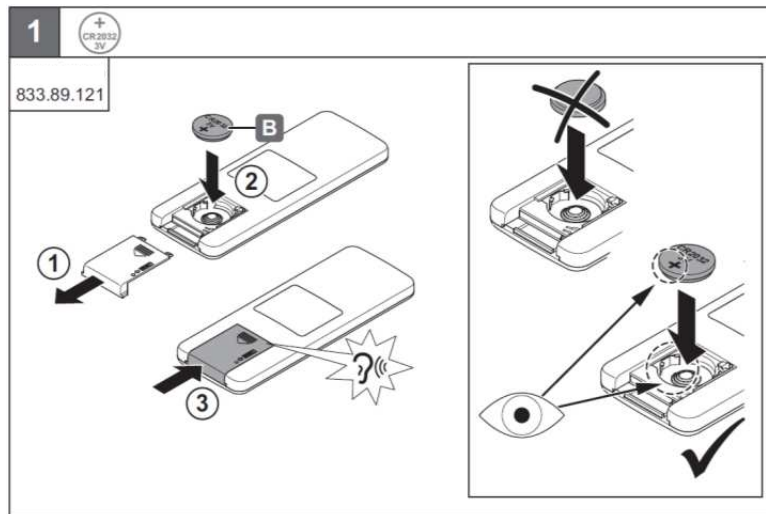

### Installing the Battery

- To install or replace the battery (type CR2032, 3V), remove battery cover.
- Pay attention to battery orientation (+ faces the battery cover).
- Slide battery cover into place until the cover snaps closed.

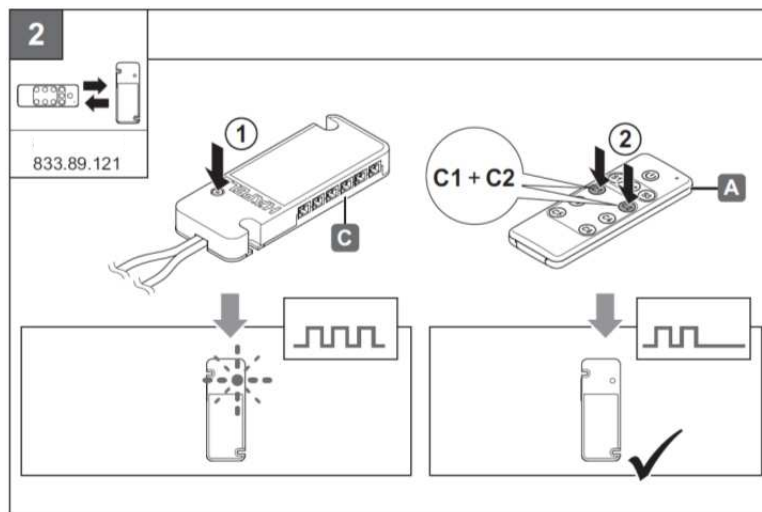

### Pairing the Wireless Remote to the Receiver Module:

- Press button located on Receiver Module Top Cover.
- Button will flash **blue**....
- Press C1+C2 buttons together on Wireless Remote.
- The Blue light on the Receiver Module will turn off.

## LOOX Mounting / Programming Instructions: Item no. 833.89.121

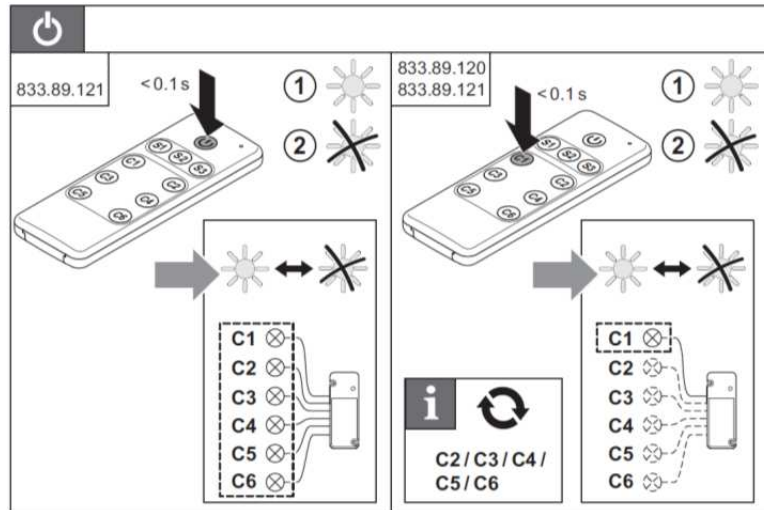

- Test the pairing by pressing the power button  or individual zones (C1, C2 C3...) on and off. Note: C1 will turn all C1 lights on /off etc.

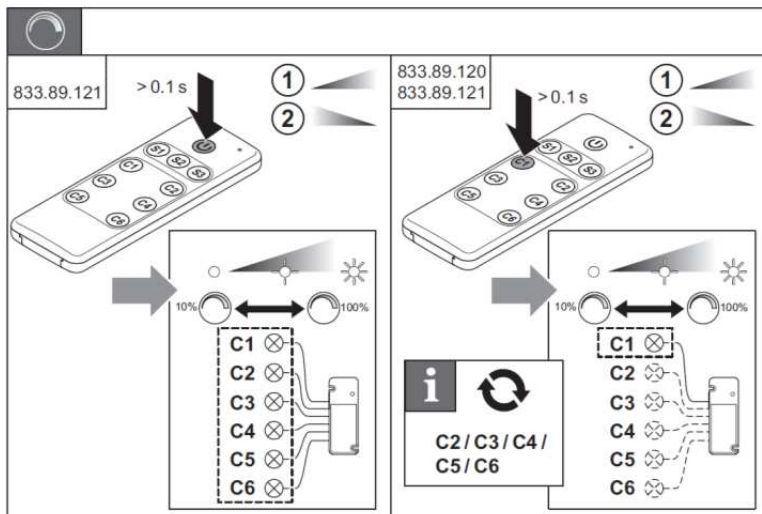

### Dimming:

- Dimming all lights or selected zones can be achieved by pressing and holding the power button  or individual (C1, C2 C3...) for greater than 1 second.
- The dimming is not cyclical. Holding the button initially only dims in one direction. To reverse the dimming, re-press the same button longer than 1 second to increase the light intensity.

## LOOX Mounting / Programming Instructions: Item no. 833.89.121

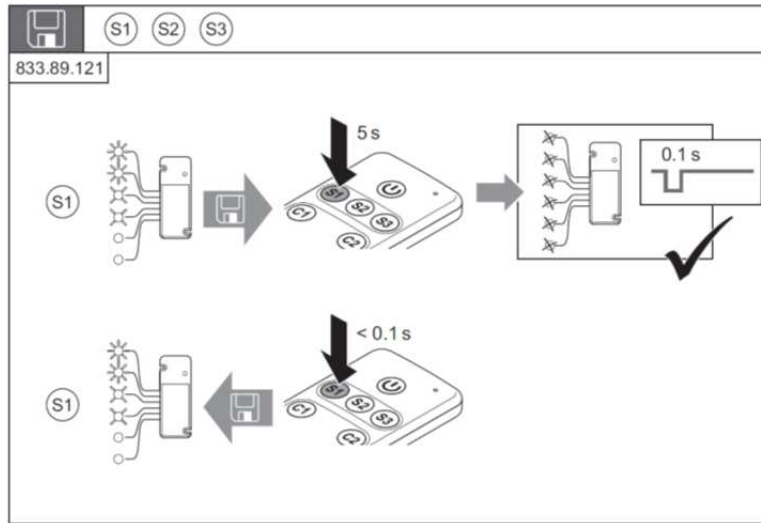

### Scene saving:

- It is possible to set each Zone to a specific light level and on/off setting independent of the other zones.
- Once each zone is set to the desired level, you may save the setting to a Scene.
- Press and hold the S1, S2, or S3 button until the lights blink in confirmation of being saved. Up to 3 scenes can be stored in a Wire Remote.

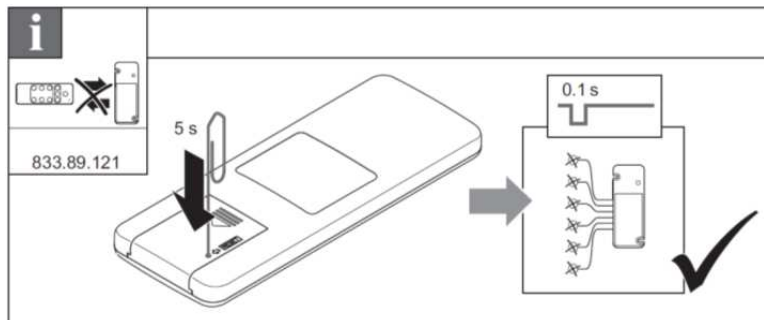

### Resetting the Wireless Remote:

- It is also possible to reset a remote and break communication with all associated Receiver Modules.
- Locate the reset button on the back of the Wireless Remote.
- Using a paperclip, press and hold the reset button longer than 5 seconds.