







**LED 4014**

**833.78.060**  
**833.78.061**

	<b>K</b>	<b>W</b>	<b>T<sub>A</sub></b>	 mm	 mm	
833.78.060	4000 K	1.0 W	-20 °C – +35 °C	Ø 40 x 20	≥ Ø 50 x 30	833.80.900 833.80.901
833.78.061	6000 K		-4 °F – +95 °F			

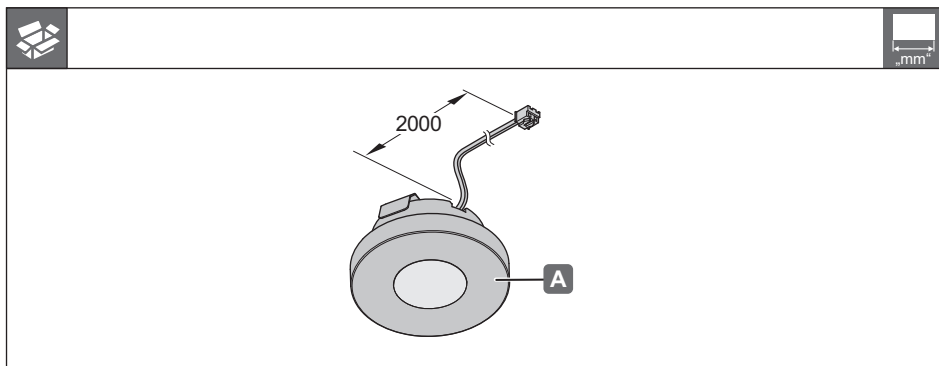

**i**

⚠



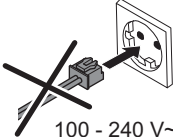

100 - 240 V~

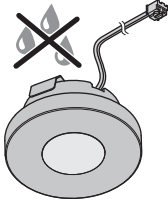

HDE 13.11.2012

732.28.276

